

## Surface Mount Super Fast Rectifiers

### FEATURES

- Glass passivated junction chip
- Ideal for automated placement
- Low profile package
- Low power loss, high efficiency
- Moisture sensitivity level: level 1, per J-STD-020
- Compliant to RoHS Directive 2011/65/EU and in accordance to WEEE 2002/96/EC
- Halogen-free according to IEC 61249-2-21 definition



**Sub SMA**

### MECHANICAL DATA

**Case:** Sub SMA

Molding compound, UL flammability classification rating 94V-0

Base P/N with suffix "G" on packing code - green compound (halogen-free)

Base P/N with prefix "H" on packing code - AEC-Q101 qualified

**Terminal:** Matte tin plated leads, solderable per JESD22-B102

Meet JESD 201 class 1A whisker test

with prefix "H" on packing code meet JESD 201 class 2 whisker test

**Polarity:** Indicated by cathode band

**Weight:** 0.019 g (approximately)

MAXIMUM RATINGS AND ELECTRICAL CHARACTERISTICS (T <sub>A</sub> =25°C unless otherwise noted)										
PARAMETER	SYMBOL	ES 1AL	ES 1BL	ES 1CL	ES 1DL	ES 1FL	ES 1GL	ES 1HL	ES 1JL	UNIT
Marking code		EAL	EBL	ECL	EDL	EFL	EGL	EHL	EJL	
Maximum repetitive peak reverse voltage	V <sub>RRM</sub>	50	100	150	200	300	400	500	600	V
Maximum RMS voltage	V <sub>RMS</sub>	35	70	105	140	210	280	350	420	V
Maximum DC blocking voltage	V <sub>DC</sub>	50	100	150	200	300	400	500	600	V
Maximum average forward rectified current	I <sub>F(AV)</sub>	1								A
Peak forward surge current, 8.3 ms single half sine-wave superimposed on rated load	I <sub>FSM</sub>	30								A
Maximum instantaneous forward voltage (Note 1) @ 1 A	V <sub>F</sub>	0.95			1.3			1.7		V
Maximum reverse current @ rated VR T <sub>J</sub> =25 °C T <sub>J</sub> =125 °C	I <sub>R</sub>	5 100								μA
Typical junction capacitance (Note 2)	C <sub>j</sub>	10			8					pF
Maximum reverse recovery time (Note 3)	T <sub>rr</sub>	35								ns
Typical thermal resistance	R <sub>θJL</sub> R <sub>θJA</sub>	35 85								°C/W
Operating junction temperature range	T <sub>J</sub>	- 55 to +150								°C
Storage temperature range	T <sub>STG</sub>	- 55 to +150								°C

Note 1: Pulse test with PW=300μs, 1% duty cycle

Note 2: Measured at 1 MHz and Applied VR=4.0 Volts.

Note 3: Reverse Recovery Test Conditions: I<sub>F</sub>=0.5A, I<sub>R</sub>=1.0A, I<sub>RR</sub>=0.25A

ORDERING INFORMATION					
PART NO.	AEC-Q101 QUALIFIED	PACKING CODE	GREEN COMPOUND CODE	PACKAGE	PACKING
ES1xL (Note 1)	Prefix "H"	RU	Suffix "G"	Sub SMA	1,800 / 7" Plastic reel (8mm tape)
		RV		Sub SMA	3,000 / 7" Plastic reel (8mm tape)
		RT		Sub SMA	7,500 / 13" Paper reel (8mm tape)
		MT		Sub SMA	7,500 / 13" Plastic reel (8mm tape)
		RQ		Sub SMA	10,000 / 13" Paper reel (8mm tape)
		MQ		Sub SMA	10,000 / 13" Plastic reel (8mm tape)
		R3		Sub SMA	1,800 / 7" Plastic reel (12mm tape)
		RF		Sub SMA	3,000 / 7" Plastic reel (12mm tape)
		R2		Sub SMA	7,500 / 13" Paper reel (12mm tape)
		M2		Sub SMA	7,500 / 13" Plastic reel (12mm tape)
		RH		Sub SMA	10,000 / 13" Paper reel (12mm tape)
		MH		Sub SMA	10,000 / 13" Plastic reel (12mm tape)

Note 1: "x" defines voltage from 50V (ES1AL) to 600V (ES1JL)

EXAMPLE					
PREFERRED P/N	PART NO.	AEC-Q101 QUALIFIED	PACKING CODE	GREEN COMPOUND CODE	DESCRIPTION
ES1JL RU	ES1JL		RU		
ES1JL RUG	ES1JL		RU	G	Green compound
ES1JLHRU	ES1JL	H	RU		AEC-Q101 qualified

**RATINGS AND CHARACTERISTICS CURVES**

(TA=25°C unless otherwise noted)

FIG. 1 FORWARD CURRENT DERATING CURVE

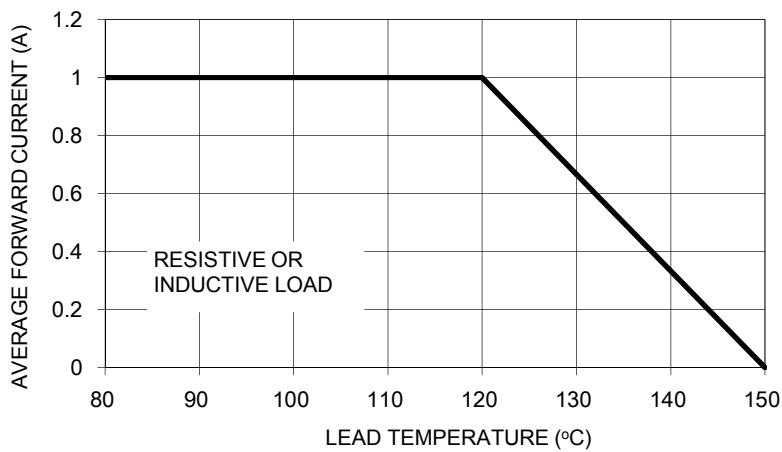

FIG. 2 TYPICAL FORWARD CHARACTERISTICS

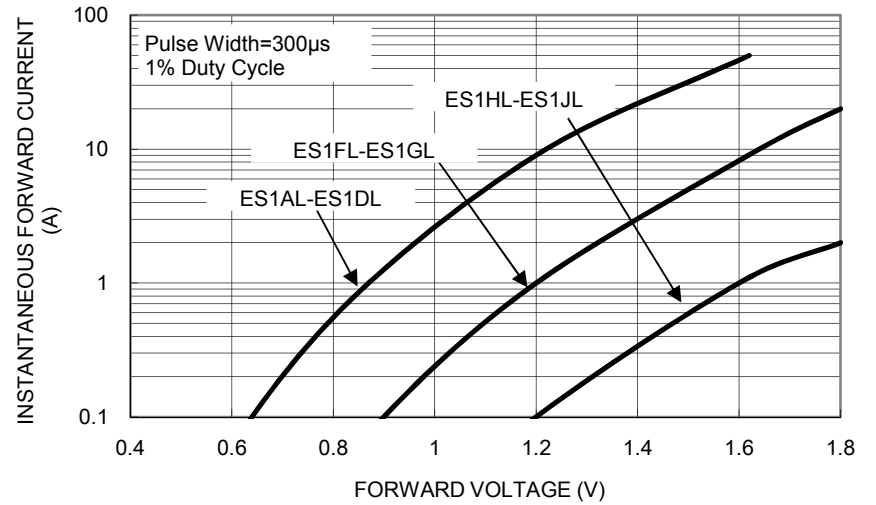

FIG. 3 MAXIMUM NON-REPETITIVE FORWARD SURGE CURRENT

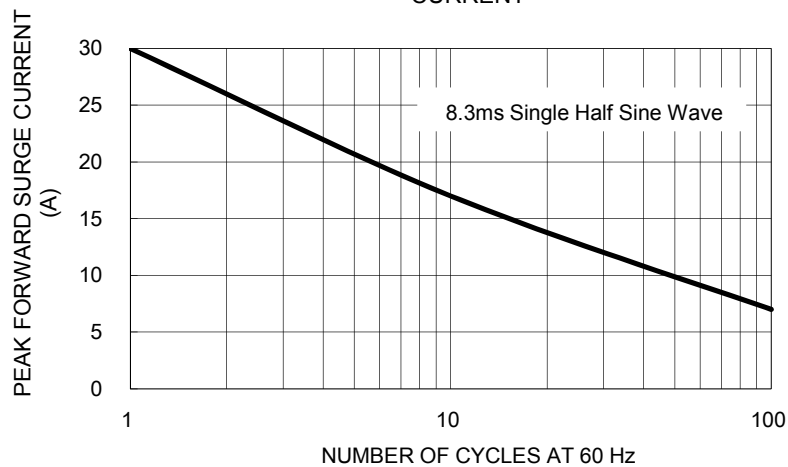

FIG. 4 TYPICAL REVERSE CHARACTERISTICS

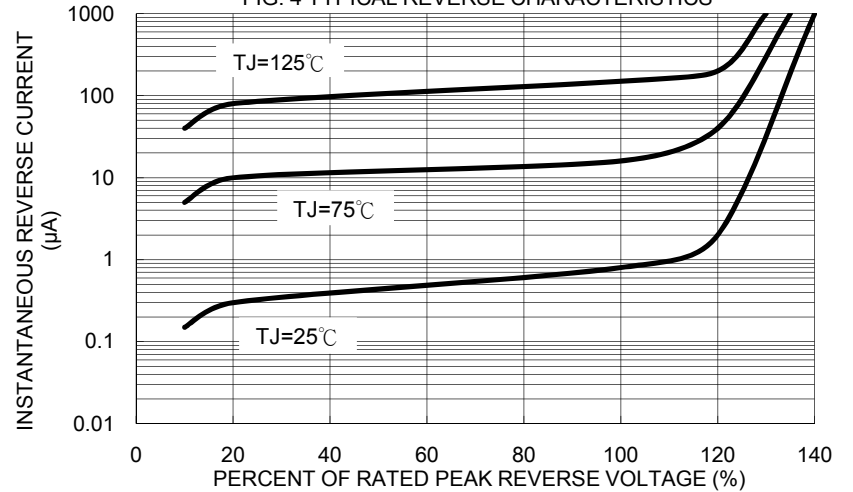

FIG. 5 TYPICAL JUNCTION CAPACITANCE

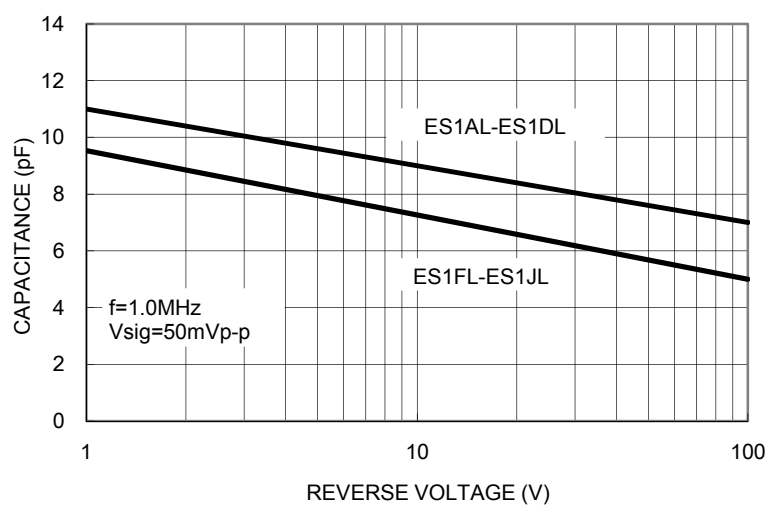
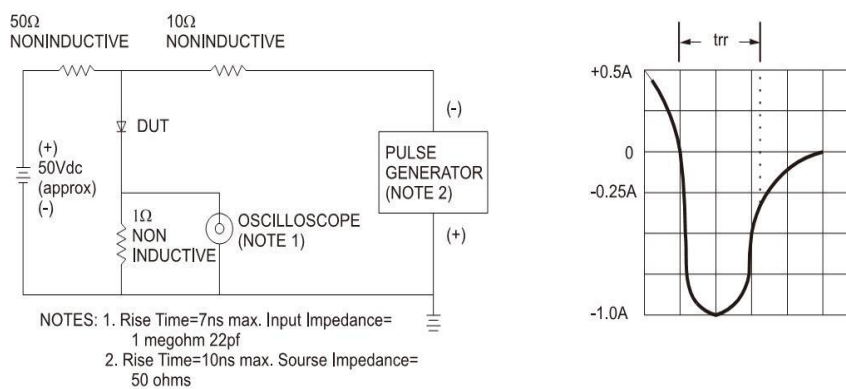
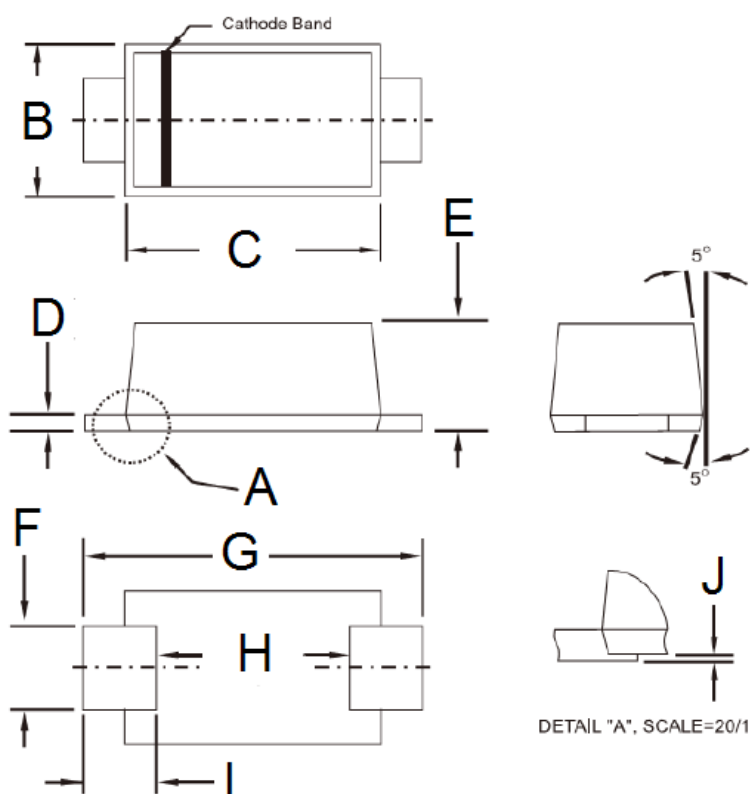

FIG.6- REVERSE RECOVERY TIME CHARACTERISTIC AND TEST CIRCUIT DIAGRAM



PACKAGE OUTLINE DIMENSIONS



DIM.	Unit (mm)		Unit (inch)	
	Min	Max	Min	Max
B	1.70	1.90	0.067	0.075
C	2.70	2.90	0.106	0.114
D	0.16	0.30	0.006	0.012
E	1.23	1.43	0.048	0.056
F	0.80	1.20	0.031	0.047
G	3.40	3.80	0.134	0.150
H	2.45	2.60	0.096	0.102
I	0.35	0.85	0.014	0.033
J	0.00	0.10	0.000	0.004

SUGGESTED PAD LAYOUT

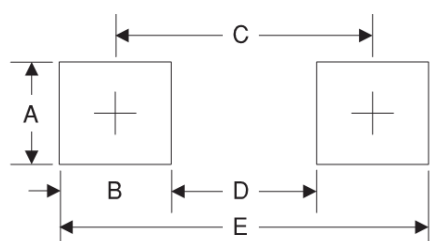

Symbol	Unit (mm)	Unit (inch)
A	1.4	0.055
B	1.2	0.047
C	3.1	0.122
D	1.9	0.075
E	4.3	0.169

MARKING DIAGRAM



- P/N = Marking Code
- G = Green Compound
- YW = Date Code
- F = Factory Code

## Notice

Specifications of the products displayed herein are subject to change without notice. TSC or anyone on its behalf, assumes no responsibility or liability for any errors inaccuracies.

Information contained herein is intended to provide a product description only. No license, express or implied, to any intellectual property rights is granted by this document. Except as provided in TSC's terms and conditions of sale for such products, TSC assumes no liability whatsoever, and disclaims any express or implied warranty, relating to sale and/or use of TSC products including liability or warranties relating to fitness for a particular purpose, merchantability, or infringement of any patent, copyright, or other intellectual property right.

The products shown herein are not designed for use in medical, life-saving, or life-sustaining applications. Customers using or selling these products for use in such applications do so at their own risk and agree to fully indemnify TSC for any damages resulting from such improper use or sale.